

Art.-Nr.	HW	D cm	L cm	W cm	G kg/pz.	CHF/pz.
senza battuta, senza base, L 100 cm						
136344	EF 23, 76	10	100	2.8	13	35.80
104256	EF 23, 76	12	100	2.8	15	35.80
135377	EF 23, 73, 76	15	100	3	20	35.80
117852	EF 23, 73, 76	20	100	3	27	38.20
114870	EF 23, 73, 76	25	100	3.5	40	46.60
115093	EF 23, 73, 76	30	100	4	50	60.50
108606	EF 23, 73, 76	40	100	5	80	82.50
122596	EF 23, 73, 76	50	100	6	124	130.00
121476	EF 23, 73, 76	60	100	6.5	155	162.00
116958	EF 71, 76	70	100	7	201	197.00
102745	EF 26, 71, 76	80	100	8	255	248.00
132701	EF 26, 71	100	100	10	395	339.00
117649	EF 71	125	100	10	510	489.00
senza battuta, senza base, L 50 cm						
108997	EF 23, 76	12	50	2.8	7.5	33.60
121258	EF 23, 73, 76	15	50	3	11	33.60
139906	EF 23, 73, 76	20	50	3	16	33.60
132563	EF 23, 73, 76	25	50	3.5	20	33.60
117862	EF 23, 73, 76	30	50	4	25	44.30
105666	EF 23, 73, 76	40	50	5	40	64.00
110588	EF 23, 73, 76	50	50	6	62	87.00
105894	EF 23, 73, 76	60	50	6.5	77.5	116.00
110321	EF 71, 76	70	50	7	100.5	158.00

Art.-Nr.	HW	D cm	L cm	W cm	G kg/pz.	CHF/pz.
115847	EF 26, 71, 76	80	50	8	127.5	223.00
111591	EF 26, 71	100	50	10	197.5	269.00
115062	EF 71	125	50	10	255	372.00

A dipendenza del luogo di produzione, le dimensioni (spessore, pareti, pesi) possono variare. Le cunette lunghezza 50 cm, vengono prodotte solo su ordinazione.

Nel caso di utilizzo quale pozzo di ventilazione, griglie e fissaggi relativi vedi Art. no. H2120 e Art. no. H2110.

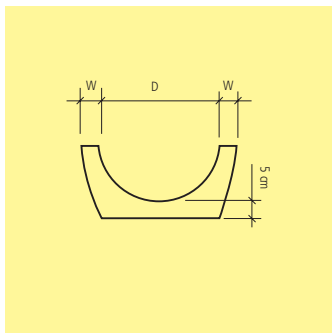
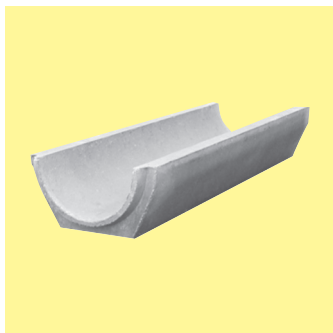

Art.-Nr.	HW	D cm	L cm	W cm	G kg/pz.	CHF/pz.
senza battuta, con base, L 100 cm						
127061	EF 76	30	100	4	80	81.50
108629	EF 76	40	100	5	115	112.00
139860	EF 76	50	100	6	190	164.00

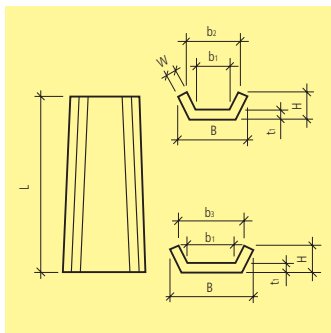
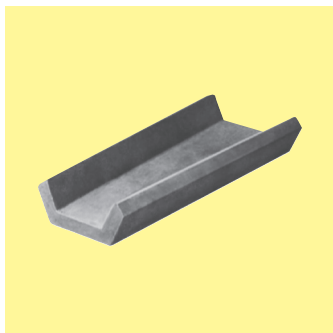

Art.-Nr.	HW	L cm	B cm	b ₁ cm	b ₂ cm	b ₃ cm	H cm	t ₁ cm	W cm	G kg/pz.	CHF/pz.
----------	----	---------	---------	----------------------	----------------------	----------------------	---------	----------------------	---------	-------------	---------

conica

107586	EH	76	100	38/46	20/28	30	38	15	5	5	60	117.00
124980	EH	76	100	54/63	30/38	45	53	21	6	6	105	155.00
102080	EH	76	100	70/78	40/48	60	68	27	7	7	135	301.00

Art.-Nr.	HW	Descr.	CHF/pz.
----------	----	--------	---------

briglia d'arresto, zincata

138692	EH	99	per cunetta per ruscelli B 38/46 cm	11.10
122827	EH	99	per cunetta per ruscelli B 54/63 cm e B 70/78 cm	13.40

Fino a 15% di pendenza con una briglia d'arresto per cunetta, oltre il 15% di pendenza con due briglie d'arresto per cunetta. Pendenza minima 8 %.

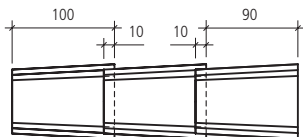

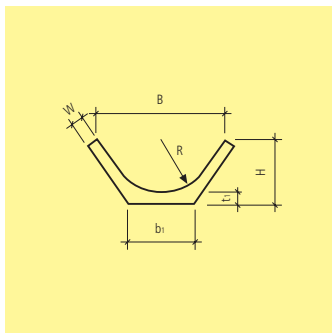

Art.-Nr.	HW	L cm	B cm	b ₁ cm	H cm	R cm	t ₁ cm	W cm	G kg/pz.	CHF/pz.
con base, con immaschiatura e battuta, R 20 cm										
100891	EH 23	100	48	30	25	20	5.5	4.5	97	178.00
137516	EH 23	200	48	30	25	20	5.5	4.5	194	349.00
con base, con immaschiatura e battuta, R 55 cm										
103901	EH 23	100	132	81	64	55	7	9.5	480	645.00

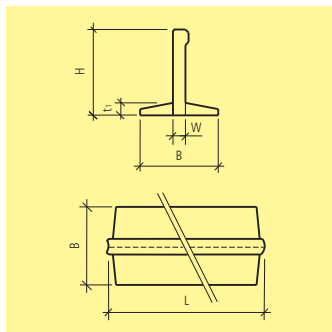

Art.-Nr.	HW	L cm	B cm	H cm	t ₁ cm	W cm	G kg/pz.	CHF/pz.
armato, con bordo di chiusura e raccordo, smussato								
110339	EM 71	140	50	55	8	8	240	342.00
123676	EM 71	300	50	55	8	8	515	605.00

Vengono prodotti su ordinazione.
Su richiesta altre lunghezze.

Possibili curvature +/- 10° per elemento.

